

Math Chains

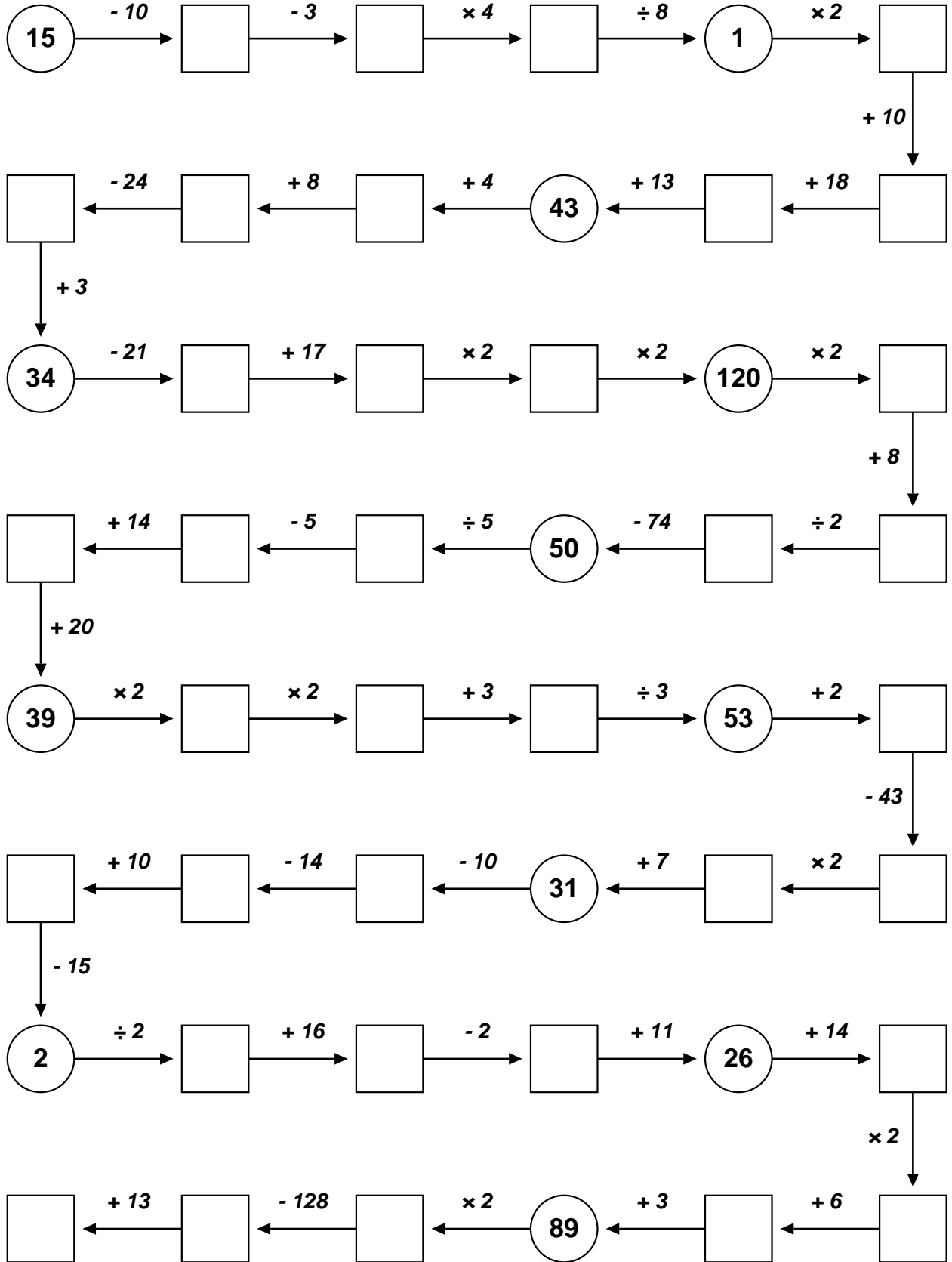

Math Chains

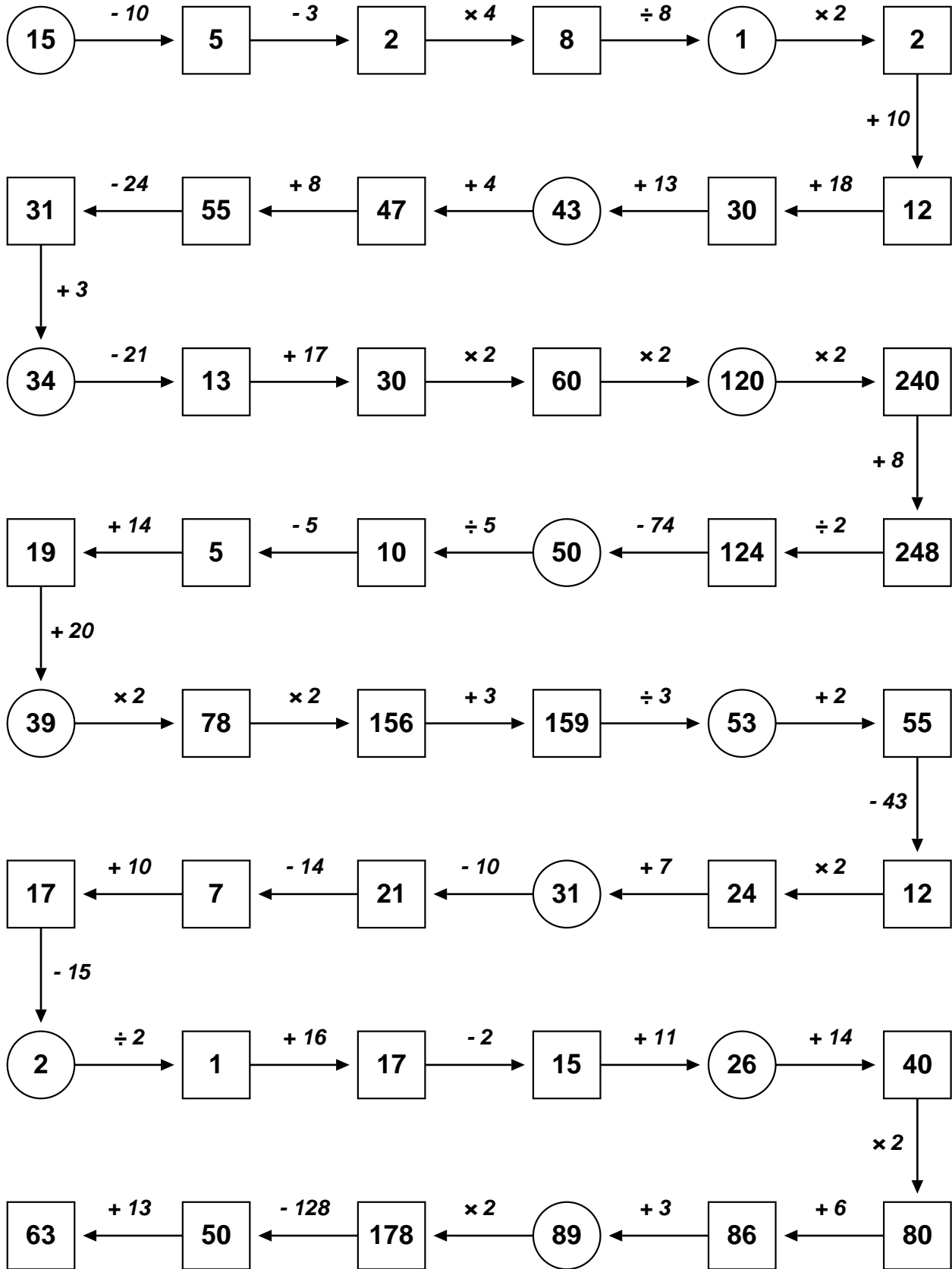

START = 15 END = 63